

BODY ARMOR

BY TOLAR MFG. CO., INC.

BUMPER INSTALLATION INSTRUCTIONS

TJ-2993 REAR BUMPER WITH TIRE CAN CARRIER SWING-ARM POST

JEEP WRANGLER TJ (1997 TO 2006) - all models including X, SE, SPORT, RUBICON, RUBICON UNLIMITED



TJ-2993 shown with optional tire/can carrier PN 5292













**Extreme trailgear
for the serious
offroader!**

Hardware Kits - TJ, Rubicon, Rubicon Unlimited

DO NOT INSTALL THIS PRODUCT ON ANY VEHICLE OTHER THAN JEEP TJ* MODELS.

Body Armor designed this product to give you years of dependability and performance. If you encounter any problems during installation of this product, or at any later date, please contact your authorized Body Armor dealer, or call 951-808-0750 for our customer service department, or check our website for tech bulletins regarding your year and model vehicle. Our hours are Monday thru Thursday 7AM-4:30PM and Friday 8AM-12PM, Pacific Time.

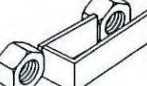
Important: Before beginning installation, assure that all parts and hardware listed for your specific bumper are contained in this package. Please contact us immediately should there be any shortages in parts and/or hardware.

Rear Bumper with Swing-A-Way - TJ*					
					
Hex head bolt 7/16-14 x 1" PN=BOLTBA716-141 QTY 4	Lock washer 7/16" PN=LWBA716 QTY 4	Flat washer 7/16" PN=FWBA716 QTY 6	Moon washer 1/2" PN = MWBA12 QTY 2	Hex lock nut 1/2" PN = HLNBA12 QTY 3	Hex head bolt 1/2-13 x 4" PN=BOLTBA12-134 QTY 1
					
Hex head bolt 1/2-13 x 1" PN=BOLTBA12-131 QTY 5	Lock washer 1/2" PN=LWBA12 QTY 4	Flat washer 1/2" PN=FWBA12 QTY 10	Hex nut retainer PN=00187 QTY 2	Hex nut 1/2" (non-lock) PN = HNBA12 QTY 2	Hex head bolt 1/2-13 x 2" PN=BOLTBA12-132 QTY 2

Outer Frame Rail Support Brackets



Special Note: On 2005 and 2006 Jeeps TJ's we have found fitment issues with the rear Swing-A-Way bumper # TJ-2991 and # TJ-2491. The models affected include Rubicon, Sport and Unlimited. Field research has revealed that the Jeep crossmember is indeed the problem, not our bumper. We examined one each of the Rubicon, Sport & Unlimited (all new on the showroom floor) and discovered that the crossmember was centilevered in at the top by approximately 3 degrees. This tilts the top of the bumper forward the same angle when bolted up and will not allow the swing arm to align and/or close properly. We have been providing 1/8" washers to shim the top of the bumper out from the crossmember, at the top bolts only, to customers upon request. Should you need these washers, please contact us, and we will ship them to you at no charge. These are standard 1/8", 7/16" id sae washers. See photo on last page for reference in placement of washers / spacers.



BODY ARMOR

BY TOLAR MFG. CO., INC.

Step 1

Using appropriate tools, remove the OE rear bumper, saving the (2) lowest mounting bolts. Our installation kit contains new grade 5 bolts with necessary attaching hardware. These should all be used in place of OE bolts and / or hardware except for the lowest bolt on each side (should OE bolts be desired).

Step 2

Bolt the support brackets to the frame rails using the "hex-nut retainers", making sure holes in rear crossmember are lined up with holes in the brackets. To install "hex-nut retainers", insert retainers into the holes in the bottom of the frame-rails and hold by inserting a finger between the clips while threading the 1/2" x 1" bolts with lock-washer and flat washer through bracket and frame into retainer (see photos on last page for reference). Hand tighten only at this time.

Step 3

Using a floor jack or a helper, hold the bumper in place while threading the 7/16" x 1" bolts with lock-washer and flat-washer through the bracket and frame-rail into the threaded backing plates in bumper. Next install OE bolts through lower tabs into frame. See photos on last page for reference. Hand tighten only at this time.

Step 4

Confirm that bumper is even side-to-side, as well as front-to-back (take measurements from outside of frame-rail to ends of bumper, and from an equal point on frame or body to the back of bumper on each side). Assured bumper is straight, torque bolts evenly starting with the top bolts into the retainers in side of frame.

Step 5 If you are not installing the tire/can carrier PN 5292 then please be sure to securely install the plastic plugs in the upper and lower holes in the bumper at the pivot bracket.

We recommend you check the torque of all bolts after about two weeks, and after every off-road / trail run thereafter to assure tightness.

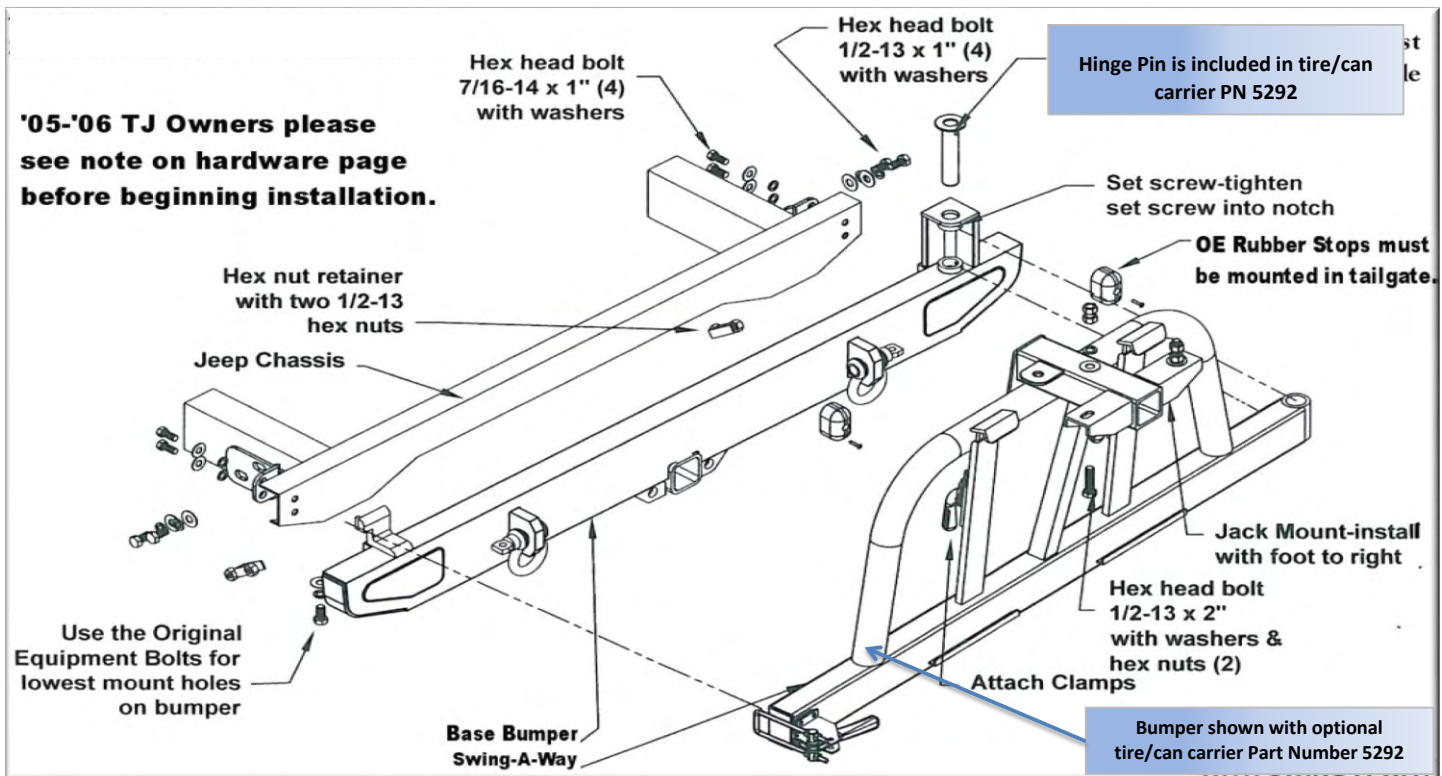

Not affiliated with Daimler-Chrysler

Jeep, Wrangler, Rubicon, Renegade, CJ, Quadra-Trac, Unlimited, and the Jeep grill design are all registered trademarks of Daimler-Chrysler.

Tolar Mfg. Inc., Body Armor has no affiliation with Daimler-Chrysler. Throughout any of our printed literature, including catalog(s), these trademark terms are used for identification purposes only. No affiliations are implied or expressed.

Check out our website for the latest in Body Armor gear, tech bulletins, and our new vehicle photo gallery.

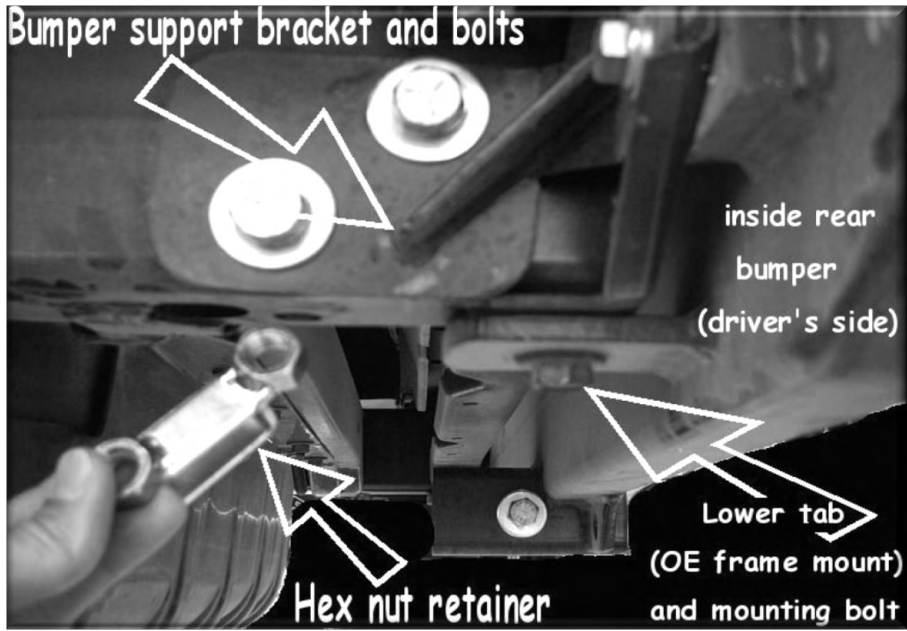

Support brackets - Hex nut retainer - Lower tab at OE frame mount

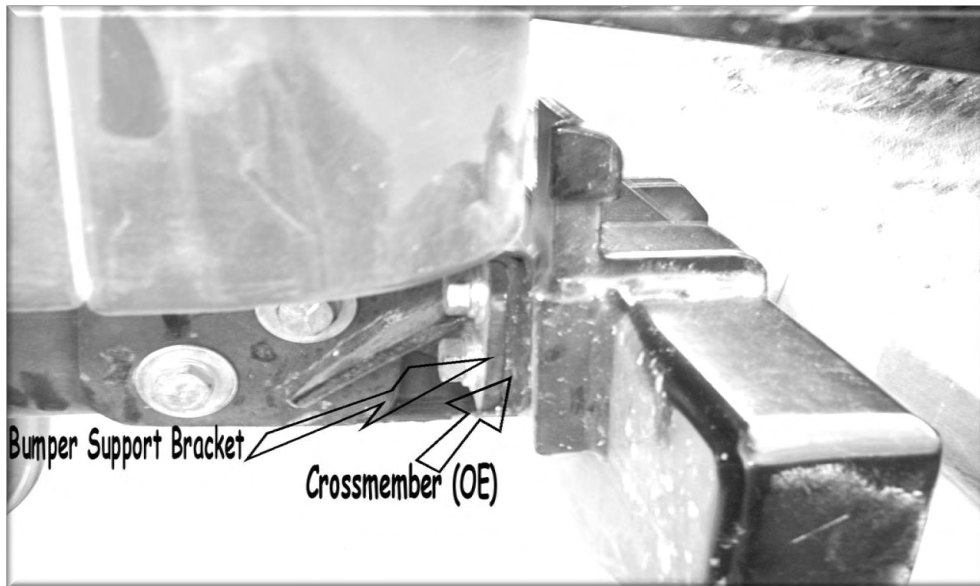

05-06 TJ owners with canted crossmember - install spacers or washers between crossmember and bumper on upper bolts only.

